SAFETY PRECAUTIONS

Only authorized and trained personnel familiar with battery installation, preparation, charging, and maintenance should be permitted access to the battery.

WARNING



SHOCK HAZARD – Do not touch un-insulated battery, connectors or terminals. Be sure to discharge static electricity from tools and technician by touching a grounded surface near the batteries, but away from the cells and flame arresters.

All tools should be adequately insulated to avoid the possibility of shorting connections. Do not lay tools on the top of the battery.



Although VRLA batteries are sealed and emit no gas during normal operation, they contain potentially explosive gases, which may be released under abnormal operating conditions, such as a charger malfunction. It is the responsibility of the customer to provide adequate ventilation so hydrogen gas accumulation in the battery area does not exceed two percent by volume. However, normal air circulation in a ventilated facility will preclude any hydrogen build-up even during equalize charging. Never install batteries in a sealed cabinet or enclosure. If you have any questions, contact your local C&D representative.



This battery contains sulfuric acid, which can cause severe burns. In case of skin contact with electrolyte, remove contaminated clothing and flush affected areas thoroughly with water. If eye contact has occurred, flush for a minimum of 15 minutes with large amounts of running water and seek immediate medical attention.

Warning

Risk of fire, explosion or burns. Do not disassemble, heat above 80°C (175°F) or incinerate

IMPORTANT FOR ADDITIONAL INFORMATION CONTACT:

C&D Technologies, Inc.
Technical Service Department
1400 Union Meeting Road
P.O. Box 3053
Blue Bell, PA 19422-0858
Telephone 1-800-543-8630 +1 (215)619-2700 FAX 215-619-7899
customersvc@cdtechno.com

Check C&D's web site for further details www.cdtechno.com

NOTE

This manual is to be used for the installation and operating of C&D's Liberty MSE or Liberty DCS series of batteries.

Table of Contents

Part 1 - Introduction	5
1.1 Cell Characteristics.....	5
Part 2 - Recommended Technical References	6
Part 3 - Safety Precautions.....	7
3.1 Recommended Tools	7
3.2 Personal Protection Equipment (Safety).....	7
3.3 Installation Equipment, Tools and Supplies.....	8
Part 4 - Receiving.....	8
4.1 Inspection at Time of Delivery	8
4.2 Damage and Shortage Situations.....	8
Part 5 Storage.....	9
5.1 Storage Conditions.....	9
5.2 Storage Temperature and Duration.....	9
Part 6 - Installation.....	9
6.1 Locating Battery System.....	9
6.2 Ventilation.....	11
6.3 Floor Loading and Anchoring	11
6.4 Spill Containment	11
6.5 Electrical Connections	11
6.6 Terminal Plates	12
6.7 Numbering Cells.....	12
6.8 Interconnection.....	12
6.9 Tap Connections	13
Part 7 - Initial Charging.....	14
7.1 Initial Charge	15
Table 1 – Charging Requirements	15
7.2 Initial Charge Records	15

Table of Contents

Part 8 - Battery Operation	17
8.1 Float Charging.....	17
8.2 Cycle Charging.....	17
8.3 Equalize or Freshening Charging.....	18
8.3.1 Equalize or Freshening Charge Float Charge Applications.....	18
8.3.2 Equalize or Freshening Charge Cyclic Applications.....	18
8.4 Temperature Effects on Batteries.....	19
Part 9 – Maintenance	20
9.1 Monthly Inspection.....	20
9.2 Quarterly.....	20
9.3 Semi-Annually.....	20
9.5 Performance Tests.....	21
Part 10 - Battery Degradation	21
10.1 General Information and Precautions.....	21
10.2 Float versus Cycle Life.....	21
10.3 Low Float Voltage and Sulfation.....	22
10.4 Hydration.....	22
10.6 Parallel Battery Strings.....	23
10.7 High Temperature Operation.....	23
Appendix	24
Appendix A – Installation of Modules.....	24
Appendix B - Terminal Connections.....	30
Appendix C – MSDS 14-355 Liberty MSE & Liberty DCS.....	31
Appendix D – Handling and Replacement of Individual Cells.....	31
Appendix E – Battery Inspection Report.....	33
Appendix F – Recycling.....	35

Part 1 - Introduction

The Liberty 2V batteries (Liberty MSE or Liberty DCS) referenced in this document are stationary, lead-acid batteries. They are constructed with an absorbent glass mat (AGM) and are characterized as Valve Regulated Lead-Acid (VRLA). As VRLA, there is no free flowing electrolyte. They are constructed with lead-calcium alloy grids, dilute sulfuric acid (electrolyte) enclosed in a flame retardant thermoplastic container (*non-flame retardant container also available*) with a safety vent and a flame arresting disk to prohibit a spark from entering the head space of the cell. This type of battery is nearly 100% recyclable. At the end of life, please dispose of properly or consult C&D for recycling information.

The Liberty 2V batteries are designed to provide reliable service life with minimal maintenance when used in accordance with this manual. They are a single cell unit producing a nominal two volts per cell, which are connected in series for the desired system voltage. The cells are housed in steel modules, coated with acid resistant paint. These modules come in varying heights, depending on the cell size and two widths (3 cells wide and 4 cells wide), and can be stacked up to 84" high while maintaining their seismic ratings.

The Liberty 2V series are to be installed in a horizontal position with all connections accessible from the front of the system assembly. These cells are not designed for operation in any other orientation.

The Liberty MSE series is designed for float operation with minimal cycling. Typical applications include Telecom, Switchgear/Control and other non-UPS applications which are subjected to 20 or fewer cycles per year.

The Liberty DCS series is designed for cycling applications. Typical applications include Off-Grid/Unreliable grid Telecom, Renewable energy or other stationary applications requiring a high number of cycles throughout the life of the cell.

1.1 Cell Characteristics

Under normal float operation, Liberty 2V batteries can be installed in proximity to electronic equipment and in computer rooms with occupied space. However, if subjected to excessive overcharge voltage, hydrogen and oxygen can be vented into the atmosphere. Therefore, lead acid batteries should **never** be installed in an airtight enclosure. Sufficient precautions must be taken to prevent excessive overcharge and containment of potential explosive off gases. All Lead-Acid batteries, including Liberty 2V, are capable of generating excessive potentially explosive gases when charged for prolonged periods at voltages higher than initial or equalizing charge. The Liberty 2V cells are equipped with a "flash arrestor and pressure relief valve" assembly that seals the cells during normal charge and operation but allows it to safely vent in case of overcharge. Removing the valve assembly can cause the release of potentially explosive gases and such action will void the warranty.

Part 2 - Recommended Technical References

These instructions assume a certain level of competence by the installer/user. Installers must have the appropriate knowledge and experience to safely install the batteries. The design of the battery room, system wiring, protection, environmental, fire, and safety requirements must comply with applicable codes required by the governing enforcement agency.

The following is a partial list of the codes that may have direct impact on your installation. This list is not meant to be comprehensive. Consult with your local building, electrical and fire protection agencies to get proper direction to the local codes that will affect your installation.

- NEC National Electric Safety Code, ANSI C2-1993 (or latest revision)
- UBC Uniform Building Code or locally applied Building Code
- IBC International Building Code

Federal Codes that may directly affect your battery room design and battery installation.

- 29CFR1926.441 Safety Requirements for Special Equipment
- 29CFR1910.151(c) Medical Services and First Aid
- 29CFR1 910.268(g) Telecommunications
- 29CFR1910.305(j) Wiring Methods, Components and Equipment
- STD 1-8.2(e) OSHA Standing Directive

The following references to IEEE documents contain relevant information. They should be consulted for safe handling, installation, testing, and maintaining standby batteries. You may also refer to the battery brochure for additional information, specific to the battery.

- IEEE 1187 “Recommended Practice for Design and Installation of Valve-Regulated Lead-Acid Storage Batteries for Stationary Applications”
- IEEE 1188 “Recommended Practice for Maintenance, Testing, and Replacement of Valve-Regulated Lead-Acid (VRLA) Batteries for Stationary Application”
- IEEE 1189 “Guide for Selection of Valve-Regulated Lead-Acid (VRLA) Batteries for Stationary Application”
- IEEE 1375 “Guide for Protection of Stationary Battery Systems”
- IEEE 1491 “Guide for Selection and Use of Battery Monitoring Equipment in Stationary Applications”
- IEEE P1578 “Guide for Battery Spill Containment”

Copies may be obtained by contacting:
The Institute of Electrical and Electronic Engineers (IEEE), Inc. IEEE
Customer Service
445 Hoes Lane
PO Box 1331
Piscataway, NJ 08855-1331
customer.service@ieee.org
or visit the IEEE web site: www.standards.ieee.org

Part 3 - Safety Precautions

This battery is designed for industrial, stationary use only and is not intended for application in vehicular, starting, lighting and ignition (SLI), and the operation of portable tools and appliances. Use in accordance with this manual or all IEEE battery procedures. Use of this product other than in accordance with these instructions may produce hazardous and unsafe operating conditions, leading to damage of equipment and/or personal injury.

Do not expose the batteries to open flame or electrical arc. Do not tamper with the vent, as this will void the warranty.

Do not use any petroleum based cleaning or lubrication solution on the battery jar or cover. Failure to follow this warning may result in damage to the container and will void the warranty.

As a notice to all technicians and personnel in the near proximity of the batteries, a BCI warning label is in plain view to indicate the potential hazards of battery systems.

Figure 1 - BCI warning label

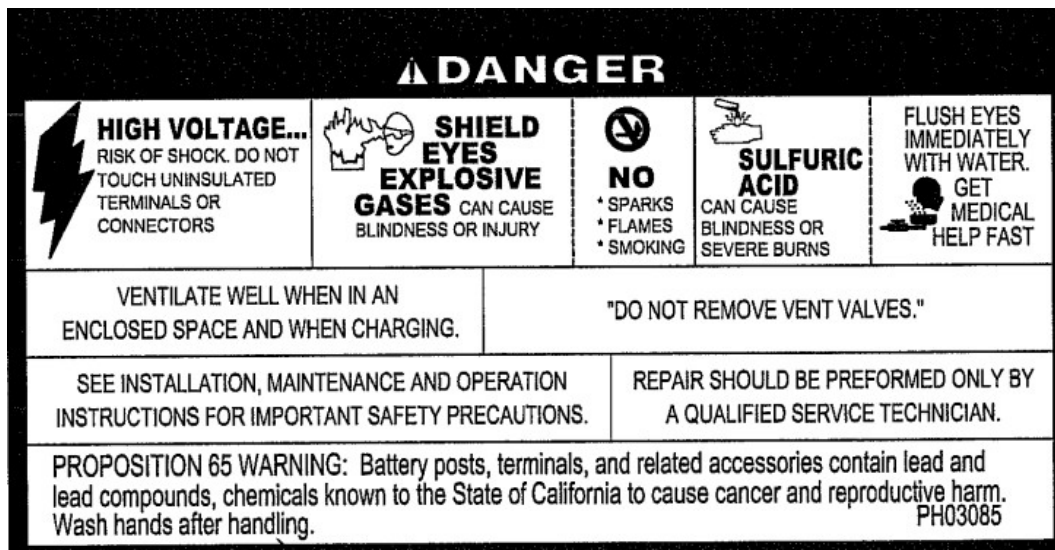

3.1 Recommended Tools

The below lists are general recommendation and is not intended as a complete and specific list. Each installation may require special tools that cannot be identified without knowing the specific applications. Review the appropriate industry recommendations, state and local codes for the specific information.

3.2 Personal Protection Equipment (Safety)

- Use standard battery safety practices
- Rubber or Neoprene – Acid Resistant Gloves
- Protective apron
- Face shield/safety glasses or ANSI approved goggles
- Rubber soled safety shoes/boots
- Portable or permanent eye wash station

3.3 Installation Equipment, Tools and Supplies

- Lifting sling or appropriately sized platform – for lifting cells into modules or modules into position.
- Fork lift or portable crane.
- Insulated steel toed safety shoes & remove all metals, i.e. rings, etc – to ensure no short circuits.
- Bicarbonate of soda, 1 lb per gallon of water – to neutralize and clean up any electrolyte.
- Metric insulated tools – to ensure no short circuits between connections.
- Insulated torque wrench – to ensure no short circuits between connections.
- Digital voltmeter with three – digits and 0.25% accuracy minimum – to record initial cell open circuit voltages & ensure correct assembly.
- Digital Micro-Ohm meter (DLRO) – to measure connection resistances.
- Optional, one of the following; resistance, conductance or impedance meter – to record initial ohmic measurements.
- Non-metallic brush or pad for cleaning connections – to ensure clean connections for good integrity.
- NO-OX-ID grease and applicator brush – to ensure good connection integrity throughout service life.
- Minimum of (2) lifting straps (lifting capacity 500 lbs + each).

Part 4 - Receiving

4.1 Inspection at Time of Delivery

Great care has been taken to pack the battery for shipment to ensure its safe arrival. As soon as you receive the battery, check the packing material for evidence of damage in transit. If the packing material is physically damaged or wet acid stains are present, make a notation on the delivery receipt **before you accept the shipment/delivery**.

NOTE:
**Freight Carriers generally require that the carriers’
representative inspect concealed damage within 10 days
from date of delivery to determine responsibility.
The resolution of such claims may extend up to nine months.**

Verify the number of cartons and skids against the bill of lading and verify their contents against the packing lists. Keep a copy of the verified lists for your installation records. It is important to confirm that the accessory package is present and the quantities are correct. If help is required, call C&D customer service department to report any discrepancies.

4.2 Damage and Shortage Situations

C&D ships FOB Pharr, TX (zip code 78577) (title/ownership passes to the ship-to/end user at the Pharr, TX warehouse). If shipments are damaged or if cartons or skids are damaged or missing, a claim must be filed with the carrier. Place an immediate order for replacement with C&D. Pay both the original invoice and the replacement invoice using the replacement cost as the amount of freight damages or shortages involved as part of your claim. If individual component items are missing, a shortage report should be filed within 30-days from the date of receiving a shipment with C&D customer service department. Mail (express mail recommended), e-mail customersvc@cdtechno.com, call 1-800-543-8630 or fax a copy of the VERIFIED component-packing list. This verified list should show both the name of the packer, as well as the quantities of items checked off by the receiver.

Part 5 Storage

5.1 Storage Conditions

Store batteries indoors in a cool, well ventilated, clean, dry location and place in service as soon as possible after receiving.

5.2 Storage Temperature and Duration

The recommended temperature for storage is 50°F (10°C) to 77°F (25°C). Liberty 2V cells may be stored at these temperatures for approximately six months; longer storage is detrimental to the cell and can void the warranty if they are not given a freshening charge within that time period. A convenient measurement to check the condition of the cell during storage is to measure the Open Circuit Voltage (OCV). A fully charged Liberty 2V cell has an approximate OCV of 2.16 volts. If the Liberty 2V series cell OCV drops more than 0.04 volts from its received voltage or measures less than 2.12 volts, a freshening charge is required. **Be sure to record dates and conditions (voltage, current and recharge times) for all charges during storage.**

Avoid exposure of a partially discharged cell to temperatures less than 0.0°F (-18°C), as this may cause the battery electrolyte to freeze. This can permanently damage the battery and can cause potentially hazardous leakage.

Higher than normal storage temperature (77°F [25°C] nominal) will accelerate internal self-discharge of a cell by a factor of two for each 15°F (10°C) over nominal 77°F (25°C) storage temperature. This, in turn, will reduce the allowable time before initial and/or boost charging.

If a freshening charge is required, it is very important that boost or freshening charges (2.35 v/c for 12 to 16 hours) be given at the appropriate time to avoid major remedial action or loss of product as noted in Part 7.

Part 6 - Installation

6.1 Locating Battery System

Install the batteries in a clean, cool, and dry location. Avoid areas with direct sunlight and heat sources, including electrical equipment vents or exhausts. The recommended battery room temperature of 77°F (25°C) provides the best combination of performance and life. Lower temperatures will reduce battery performance, while higher temperatures will improve battery performance but reduce battery service life.

Avoid sources of hot or cold air that could cause temperature variations of $\pm 5^{\circ}\text{F}$ (3°C) within the battery assembly. Such variations will compromise optimum battery performance such as the float voltages of individual cells.

For additional information on installing batteries in modular systems, refer to the Appendix for installation details.

When considering room layouts and determining the necessary floor space required for mounting a given system the below diagram is a guide to C&D's recommended system clearances. Should a question or concern arise please contact your C&D sales representative for further details. Each system is shipped with an Applications Engineering System layout which goes into further detail on system layouts and floor anchoring.

Notes:

1. Allow a minimum of 2.00" from the back of any system to a wall or any other obstruction/equipment.
2. Allow a minimum of 4.00" between systems (side to side) where no side termination is being used. Reference supplied C&D connection diagram for additional details.
3. Allow a minimum of 6.00" between systems (side to side) where side termination is being used.
4. Allow a minimum of 4.00" spacing from any wall/equipment to the side of any system.
5. When installing systems back to back allow a minimum of 2.00" spacing from module to module as shown in the diagram below.
6. Always allow for a minimum of 36.00" aisle space in front of the system for suitable handling equipment.
7. There may be a de-rating of anchor bolt load ratings due to the proximity of anchor holes. Reference anchor bolt manufacturer's data for additional information.

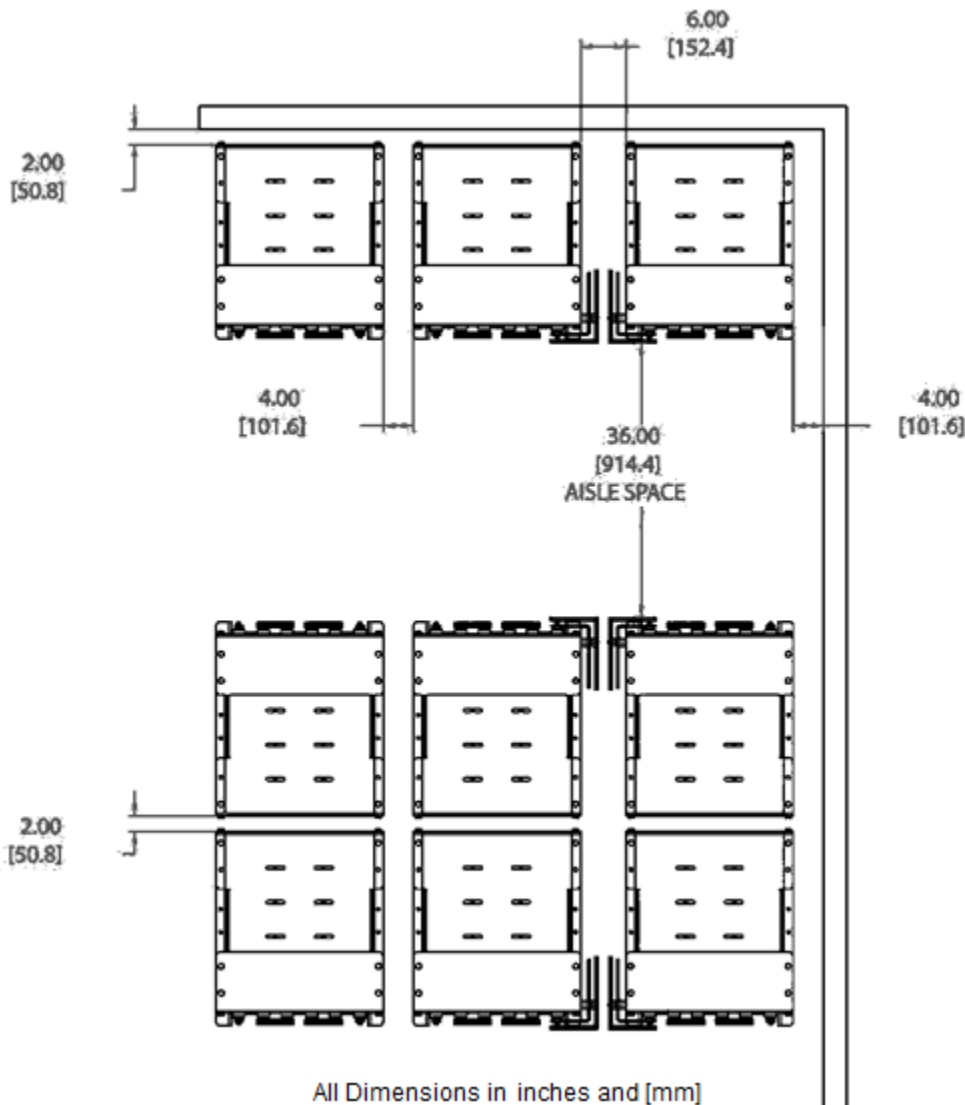

6.2 Ventilation

Although the Liberty 2V batteries are valve regulated, they can produce minimal gas emissions during normal operation. If exposed to abnormal high voltage charging, the cells may vent potentially explosive hydrogen gas. Hydrogen gas when accumulated in a confined area that exceeds four (4%) percent by volume in air is explosive. C&D recommends not allowing hydrogen gasses of greater than one (1%) percent by volume to accumulate. Contact the local code enforcement officer to determine what codes and levels are applicable to your battery room installation. **Lead acid batteries should never be installed in a sealed, non-ventilated cabinet or enclosure.**

VRLA batteries subjected to extreme overcharge voltages have the potential to release hydrogen gas at a rate of 0.000269 cubic feet per minute per ampere of charging current at 77°F (25°C). The Liberty 2V series testing shows that they recombine at nearly 99% efficiency under normal conditions. However, compliance with appropriate safety measures regarding hydrogen evolution is essential for the safety of the equipment and personnel.

6.3 Floor Loading and Anchoring

Floor loading and anchoring requirements are the responsibility of the user/installer and all applicable building codes and regulations must be followed. C&D provides connection drawings, weights, dimensions, and floor loading information on our system drawings for reference which is supplied with every shipment.

The Liberty 2V floor-mounting base has provisions for floor anchoring. Consult the applicable building codes and regulations for specific requirements. **In all cases, floor anchoring is considered mandatory with floor anchors to be installed in all locations provided unless otherwise specified.** Floor anchor sizing and hardware are the responsibility of the user/installer.

6.4 Spill Containment

Although the Liberty 2V batteries contain no free flowing electrolyte, it is the sole responsibility of the user/installer to follow all local building and fire codes applicable to the battery installation. It is recommended consulting the local fire marshal or building inspector to determine if spill containment is required.

6.5 Electrical Connections

WARNING:

- **Always use protective insulating equipment, such as gloves, shoes, eye and face protection. Wrenches and other tools must be properly insulated.**
- **Observe local, state, and national electric codes at all times. Always work with the battery ungrounded. Battery ground connections, if required, should be made last.**
- **To avoid working with high voltages, break the battery down into convenient lower-voltage modules, equal to or less than 48-volts.**
- **Always maintain a firm grasp on tools and hardware when working on the battery. Dropped hardware can cause a short circuit, possibly resulting in serious personal injury and/or damage to the equipment.**
- **Before working on the battery, be sure to discharge static electricity that can build up on tools or the technician by touching a grounded surface in the vicinity of the battery.**

6.6 Terminal Plates (If part of the battery system)

For reasons of safety, it is recommended that terminal plates be installed before connector installation as described in section 6.8. Interconnect cells and modules with tin-plated (standard) copper connectors and 6mm stainless steel hex head bolts and washers in accordance with the connection diagram supplied with each battery shipment.

Prior to installation, lightly brush (with a plastic brush or burlap) the battery terminals and terminal plate contact surfaces. Then apply a thin coating of NO-OX-ID type grease. The Liberty 2V battery terminals are made of a brass alloy with a tin coating cast inside a lead terminal. Terminal plates are made of copper with a thin tin coating. Once coated with protective NO-OX-ID type grease, any “exposed”, “un-tinned” areas, no matter if from the factory or due to over brushing, will be protected from oxidation by the grease thus not require reworking. Optional: preheat the NO-OX-ID type grease and apply warm. After working with any lead component, wash your hands.

California Proposition 65 Warning:

Batteries, battery posts, terminals and related accessories contain lead and lead compounds, and other chemicals known to the state of California to cause cancer and birth defects or other reproductive harm. **Wash hands after handling.**

6.7 Numbering Cells

For ease of identification and for record keeping, all cells of a battery should be numbered. Plastic peel-and-stick numbers are furnished in the accessory kit. Common practice is to start with “1” on the cover of the incoming (+) positive terminal of the battery and follow the electrical circuit with succeeding numbers on the cell covers.

6.8 Interconnection

Cell series connection is made from the (+) of one cell to the (-) of the next sequential cell. It is essential that the cell location and orientation match the included drawing. All connections must be made as indicated on the drawing with no deviations. If no drawing is provided or it is lost, contact C&D before making any connections.

The cells ship with NO-OX-ID grease applied by the factory to the terminals, however it may be necessary to rework prior to connecting the cells with the supplied inter-cell connectors. Refer to the Appendix for additional instructions for reapplying NO-OX-ID grease.

Prior to installation, lightly brush (with a plastic brush or burlap) the battery terminals and any contact surfaces of the inter-unit connections. Then apply a thin coating of NO-OX-ID type grease to both the battery terminals and contact surfaces of the inter-unit connectors prior to installation. The Liberty 2V battery terminals are made of a brass alloy with a thin tin coating cast inside a lead terminal. The inter-unit connectors (cables and bus bars) are made of copper and have a thin lead or tin coating. Once coated with protective NO-OX-ID type grease, any “exposed”, “un-tinned” coated areas, no matter if from the factory or due to over brushing, will be protected from oxidation by the grease thus not require reworking. Optional: preheat the NO-OX-ID type grease and apply warm. After working with any lead component, wash your hands.

The top row of connectors is to be installed first, then the second row down and so on, working from the top down. When installing connectors, install the top (upper most) bolt first. Complete connector installation by torquing all connections to 110 in-lb. [12.4 N-m], using an insulated torque-wrench.

NOTE:
**Over-torquing can damage the post seal
and degrade connection integrity.**

After torquing all connections and with the battery still on open circuit (not connected to the charging source), take post-to-post resistance measurements. Start at one end of the string and work to the other end, recording micro-ohm resistance of each inter-cell connection between cells. Clean and re-torque connections (see Appendix B) of similar size connectors which exceed $\pm 10\%$ percent of the average resistance of battery connections or five micro-ohms, whichever is greater.

IMPORTANT:
**Record and retain the resistance readings with the
initial charge information for future reference. See Appendix E.**

CAUTION:
**It is the sole responsibility of the user to check connections.
Never operate a battery with loose or corroded connections.**

When checking connections, disconnect the battery from the load and the charging equipment and follow all the precautionary measures outlined above and in the general safety references. Some resistance measurement equipment may cause a spark when the probes are applied to the cell posts. Use appropriate safety precautions when conducting this measurement.

Typical cell and connection resistance values are provided in the Appendix according to cell type. In addition, a listing of short circuit current in amperes is provided to further inform the user of the potential energy available from these batteries.

After connecting all cells of the battery, check the battery voltage using a calibrated digital DC voltmeter with at least three digits and 0.25% accuracy minimum. Battery voltage should equal the open circuit voltage of an individual cell multiplied by the number of cells in the battery. Example: (24 cells) x (2.16 VPC) = 51.84 OCV. If the OCV does not equal the expected value, inspect the sequence of (+) to (-) connections. Further investigation may require re-inspecting each cell voltage to confirm an acceptable value.

6.9 Tap Connections

Tap connections may electrically unbalance the battery system and **may void the warranty**. If a center tap is used, each side must have its own charging unit.

Part 7 - Initial Charging

General Information and Precautions

To safely charge the Liberty 2V batteries and avoid damaging the battery and/or connected equipment, observe the following:

- Use a constant voltage charger with only direct current (DC). AC ripple current from charger shall not exceed (5%) of the 8-hour (ampere-hour) rating of the battery.
- Be sure charger is turned off before making electrical connections between the battery and system.
- Connect via the appropriate size cable. Verify polarity with a volt meter before making final charger connections and turning on the charger.
- Be certain that all connections are tight and secured before turning on the charger.

The recommended method of providing an initial/freshening charge (section 5.2 and section 7.1 & 7.2) is to first determine the maximum allowable voltage that may be applied by the connected equipment. Divide this by the number of cells in the battery to obtain maximum average voltage per cell allowed by the equipment. Adjust this number to a recommended value found in Table 1 and continue charging at this voltage.

NOTE:

Charging current to the battery should be limited based on the Ampere Hour capacity of the battery. Refer to Table 1 for maximum charging current. Higher charging current can cause overheating that subsequently increases the internal resistance of the battery, which requires additional current to compensate for the increased internal resistance. This cycle is referred to as “thermal runaway”, which has the potential to destroy the battery and cause damage to equipment.

7.1 Initial Charge

All cells are shipped fully charged from the factory with no need for an initial freshening or equalization charge. The cells should be constant voltage charged at the average float voltages as noted in Table 1 below. However, when in storage or transit for an extended period (especially at temperatures above 77°F/25°C) or when the number of cells is greater than 24 cells; it is recommended the battery system be given an initial freshening charge (see Table 1) at installation.

Table 1 – Charging Requirements

Cell Type	Average String Float Voltage 77°F (25°C)	Average String Cycle Service Voltage 77°F (25°C)	Average String Freshening Voltage	Freshening / Equalization Charging Time	Maximum Charge Current
	VPC	VPC	VPC	Hours	Amps per 100Ah battery rating
Liberty MSE	2.25 to 2.30	Not Recommended	2.35 +/- 0.02	12 – 16	25
Liberty DCS	2.25 to 2.30	2.4 to 2.45	2.35 to 2.40 +/- 0.02	12 – 24	30

Notes:

- Battery float voltage should be set at Table 1 average cell voltage multiplied by the number of cells in the battery string. Individual cell float voltages may vary by +0.10/-0.05 volts from the average in a single string.
- Average string float voltage must be adjusted based on temperatures which are above or below 77°F (25°C) - see section 8.4.
- Charging time will vary due to temperature if cell temperature is below 60°F (16°C), double the charge time for initial or equalize charge.
- If a battery load test will be performed within 90 days of installation, an initial freshening charge followed by a 72 hour float charge (per IEEE 1187) is required to ensure full capacity.

7.2 Initial Charge Records

At the completion of the initial charge and after the cells have been on float charge for approximately one week, record voltages of the individual cells, the total battery voltage and ambient temperature. Retain this information in your files for future reference. This information establishes a baseline for future reference. The information below must be recorded or refer to RS-1992 found in the Appendix E. Make a photocopy of the form and use it whenever necessary to record readings taken on the battery.

Battery identifications

1. Date of readings
2. Battery total float voltage
3. Ambient operating temperature
4. Date and description of initial or last equalizing charge
5. General observations from visual inspection
6. Individual cell voltages
7. Connection resistance measurement
9. *Optional: One of the following for cell ohmic testers:
Impedance, Conductance or Resistance
10. Name of inspection technician

If you observe any unusual readings or visual indications, consult your C&D Technologies Representative and send a copy of your latest maintenance report to your local C&D Representative or the technical services department at C&D.

*Cell ohmic readings may vary by $\pm 20\%$ of the C&D Technologies published values. This variation does not necessarily indicate a problem with the condition of the battery.

IMPORTANT:

Initial charge records are essential for review by C&D Technology's sales/service representatives in the event of a problem. Since records can materially affect your warranty, be sure to maintain clear, signed, and dated copies.

Part 8 - Battery Operation

8.1 Float Charging

Standby batteries are connected to control circuits, which must be energized at all times. Liberty MSE 2V batteries must be constant voltage charged as described in section 7. Connected to a load in parallel with a continuously operating power supply, these batteries assure instantaneous support of the load in the event of a power failure or brownout. In addition to operating the connected load, the power supply keeps the standby battery fully charged. This parallel interconnection and operation is called float service. Maximum battery life can be expected in full float service, in which the frequency and depth of discharges are kept at a minimum. Deep and/or frequent discharges can shorten service life, even with proper battery maintenance.

8.2 Cycle Charging

Note: Numerous cycle charge algorithms are permissible with the 2V Liberty DCS cells and if the specific charge algorithm is not explicitly stated in this manual please contact your C&D technical representative for further information.

Cycling applications are the most demanding applications that lead acid batteries are subjected. In many cases, the batteries are in a constant state of either being charged or discharged. Knowing how the system operates is critical to understanding how the batteries should be charged.

In typical conditions, the battery is fully charged after every discharge cycle. Under these circumstances, the battery will be brought back to full charge using a charging rate designed to bring the batteries back to full charge before the next discharge. If the system cannot achieve a full charge between discharging cycles, or if the system is being utilized in a PSoC operation, then additional charging needs to be employed to bring it back to full charge at least once month. The charging system should be capable of automatically adjusting the charging voltage based on the temperature of the battery. The measurement of the battery temperature must be taken at the battery; not ambient temperature. Please see section 8.4 for additional information.

In float applications with deep or frequent discharges, battery service life can be maximized by following recommended cycle charge voltages and currents as shown in Table 1 (Section 7.1). The 2V Liberty DCS cells can be both constant voltage and constant current charged, provided a voltage limitation is set at the values recommended in Table 1 (Section 7.1). In addition, partial state of charge operation (PSoC) is permissible if state of charge regulation is provided or periodic equalization charging is utilized (see section 8.3).

In pure cycle applications, where the battery is either in discharge, recharge, or open circuit stand, with the depth of discharge (DoD) ranging from 5-90%, either a constant voltage charge algorithm or a constant current charge algorithm is permissible, provided a voltage limitation is provided. Voltage and current limits provided in Table 1 (Section 7.1) should be utilized to ensure maximum service life. Pure cycle applications will also require a periodic equalization or freshening charge, depending on the time between discharge cycles. Generally bi-weekly or monthly equalization charging is adequate for most applications including PSoC applications where the average state of charge is between 30-90% SoC. Equalization charging, for cyclic applications, should follow the procedures outlined in section 8.3.2

8.3 Equalize or Freshening Charging

8.3.1 Equalize or Freshening Charge Float Charge Applications

Under normal float charge operating conditions, it is not necessary to equalize or freshen the Liberty 2V batteries when used within the criteria described in sections 5.2 and 7.

NOTE:
**Some hydrogen gas may be liberated
at equalize charging voltage.**

An equalizing charge should be performed if individual cell voltages fall 0.05 volts below the average float voltage as specified in Table 1 (Section 7.1). Presence of a minimum voltage does not imply a battery is malfunctioning or that it will not provide the necessary power when called upon.

NOTE:
Charging current to the battery should be limited based on the Ampere Hour capacity of the battery. Refer to Table 1 for maximum charging current. Higher charging current could potentially destroy the battery by overheating that subsequently causes more current to flow creating a cycle sometimes referred to as “thermal runaway”.

8.3.2 Equalize or Freshening Charge Cyclic Applications

In cycle charge applications, depending on how the system is designed the batteries are regularly discharged and regularly re-charged. In these applications, the charging system should be sized so that, on the average, the battery is returned to between 85 to 90% state of charge daily. On a bi-weekly to monthly basis the battery should be charged to 100% or fully charged state using the equalization parameters outline in Table 1 (Section 7.1) for equalization/freshening charge for 2V Liberty DCS.

If the system is a solar-only system then the charging strategy is solely based on the photovoltaic panels returning all of the energy to the battery every day. The ratio to the photovoltaic array to the load during the worst conditions should be able to bring the batteries to full charge at least once a month.

If the system is a hybrid system where there is dispatchable battery charging capability, the batteries should be charged to between 85 and 90% of full charge on a daily basis (daily charge). Monthly they should be given an equalization charge to insure that they were fully charged and the SoC is reset.

NOTE:

Use the equalize voltage setting as shown in Table 1 (Section 7.1) for a period not exceeding the specified hours depending on service conditions.

Consult your C&D Technologies Representative for additional information.

8.4 Temperature Effects on Batteries

C&D recommends that the battery be operated at 77°F (25°C) ± 10°F (5.5°C). For ambient temperatures outside the recommended temperature range, the float voltage must be adjusted by 2mV per °F or 3.6mV per °C. Adjust as indicated below.

Add 2mV (0.002 volts) per °F or 3.6mV per °C below 77°F (25°C). Subtract 2mV (0.002 volts) per °F or 3.6mV per °C above 77°F (25°C).

If the battery is operated at temperatures below the recommended range, the capacity will be reduced even with temperature compensated charging, which must be accounted for during initial system sizing.

Part 9 – Maintenance

9.1 Monthly Inspection

The Liberty 2V battery is a VRLA cell which does not require water addition and no specific gravities or water levels need to be checked throughout its life. However, it is recommended to properly follow the below maintenance procedure, to assure that the batteries are well maintained and ready for operation when needed. A blank inspection report is shown in Appendix E.

1. Visual inspection of the battery for general appearance and connector conditions. Check for bulging jars, corrosion build up or any signs of heat damage to the jars/covers and connectors.
2. Measure and record the total system float voltage.
3. Measure and record the total system float current.

9.2 Quarterly (including the above)

4. Optional; measure and record one of the following ohmic measurement: conductance, impedance, resistance or internal resistance of each battery. Changes over time of less than $\pm 20\%$ are acceptable, changes of greater than 50 % require further attention (such as a load test).
5. Measure and record the temperature of the negative terminal on each cell.

9.3 Semi-Annually (including the above)

6. Measure and record the individual cell voltages.

9.4 Annually (including the above)

7. Torque cell bolts to 110in-lbs (12.4 N-m). Any disassembled connections should be retorqued to 110 in-lb (12.4 N-m).
8. Measure and record connector resistance reading. If a value exceeds the average by 10% for similar connections, see Appendix B and reference IEEE 1188 for more information.
9. If possible, measure and record the total and individual AC ripple current or voltage.

Clean products with a solution of 1 lb of bicarbonate soda to 1 gallon of water, if necessary

	Initial Torque	Maintenance Re-Torque
Terminal Connectors	110 in-lbs (12.4 N-m)	110 in-lbs (12.4 N-m)
Module to Module Bolts	40 ft-lbs (55 N-m)	40 ft-lbs (55 N-m)
Restraint Bolts	40 ft-lbs (55 N-m)	40 ft-lbs (55 N-m)

CAUTION:

Never use solvents to clean a battery system. Only use a solution of water and bicarbonate soda, 1 gallon to 1 lb.

For more information, IEEE 1188 discusses the significance of connection integrity, further maintenance techniques, and testing information.

9.5 Performance Tests

If desired by the customer, a full-load performance test can be conducted at the user's original specified discharge rate or the appropriate rate based on connector sizing per the following procedure:

- Equalize charge the batteries if necessary, refer to section 8.3 equalization notes.
- Let batteries float for 72-hours.
- Perform the annual inspection.
- Run a discharge test at the system designed rate per IEEE 1188.

Part 10 - Battery Degradation

10.1 General Information and Precautions

When properly maintained and charged, the Liberty 2V batteries should provide many years of trouble-free service. However, despite their inherent dependability, failure to operate and maintain them correctly can lead to damage, shortened service life and possible loss of service. The following sections address some of the most frequently encountered errors.

10.2 Float versus Cycle Life

Standby batteries such as the Liberty MSE are designed and constructed to provide long life in continuous float service. They differ in their design from the 2V Liberty DCS cycling batteries. Standby batteries are continuously charged at a comparatively low float voltage in parallel with the load, ready to supply instantaneous DC power either directly to the load or by way of interfacing electronics, such as an uninterruptible power supply (UPS) system. The name "stationary" implies the battery is usually permanently placed in a given location and not transferred from place to place in its service life.

As such, standby battery life is directly affected by and will be degraded if subjected to repeated cycling. Depth of discharge, number of discharges, rate of discharge, and the interval between discharges are all determining factors in battery life. Cycling should therefore be kept to a minimum. To ensure that the battery will perform during power outages and other emergencies, it is strongly recommended that testing be kept to a minimum in accordance with the following practices:

- The performance of an initial acceptance test not to exceed user's originally specified system reserve time.
- A full-load service test should be performed not more than once every 12 months to verify battery capacity at user's originally specified discharge rate.
- A monthly transfer test not to exceed 30 seconds of battery discharge time at user's originally specified discharge rate to verify system load transfer and electrical system performance.
The time that is required to synchronize the UPS and return to rectifier power must be taken into account when calculating total discharge.

The user is expected to maintain complete records of all battery testing and emergency discharges in order to comply with the requirements of the warranty.

Liberty DCS cells are specifically designed for cycle service and while their robust design allows them to be used in numerous types of cycle applications from mild shallow DoD service to continuous PSoC service, battery service life can be maximized by following recommended cycle charge voltages and currents as shown in Table 1 (Section 7.1). In addition, following recommended equalization charging procedures, temperature compensation guidelines and maintaining accurate SoC and DoD limitations will ensure the Liberty DCS cells provide long and reliable cycle service.

CAUTION:
RECHARGE BATTERIES AS SOON AS POSSIBLE AFTER AN EMERGENCY DISCHARGE. Failure to recharge batteries immediately after emergency discharge may lead to sulfation, or in the case of deep discharge, a complete battery failure due to hydration. If recharging at freshening/equalize voltage is impractical, promptly recharge at float voltage.

10.3 Low Float Voltage and Sulfation

Either because of incorrect charger voltage adjustment, excessive intermittent or static loads paralleling the charging source, low operating temperature or simply not fully recharged; a battery may not receive adequate charging voltage. In some cases, the charger may even be turned off, erroneously or by choice. The net result is a battery left in a partially discharged or undercharged condition. The first observable signs may be erratic cell voltages. Although not visible to the observer, the plates will become sulfated.

If you suspect sulfated plates, contact the C&D Technical Services Department 1-800-543-8630 or (+1) 215-619-2700 for assistance. Sulfated batteries are not fully charged batteries thus have not completed the electrochemical reaction of recharge. Accordingly, they will have reduced capability. If allowed to remain in a partially charged condition for an extended period of time, sulfated batteries may suffer irreversible damage, requiring replacement.

10.4 Hydration

A battery that has been severely over-discharged and left in a discharged condition without immediate recharge is subject to damage known as hydration. This is a phenomenon in which the electrolyte specific gravity has been reduced to a value so low it permits the lead components to dissolve into the electrolyte.

The reaction of dissolution forms many compounds and salts, generically referred to as hydrate. On recharge these compounds react to clog separator pores and form metallic lead. As time passes thousands of short circuit paths are created in the separators placed between the positive and negative plates to provide electrical insulation. Very often, the effect of these short circuits goes unnoticed except for a slight increase in charging current. As the reaction continues, however, short circuits become so extensive it is almost impossible to keep the cells charged. Finally, the cells experience total failure. Liberty 2V batteries are more resistant to hydration than typical wet cells, largely because of the thick absorbent glass mat separator between the plates. However, in severe cases of hydration, internal short circuits can form.

10.5 Open Circuit – Late Installations

As soon as a battery is disconnected from a charger, local action (self-discharge) begins. This is caused by inherent internal losses within the cell. In the case of Liberty 2V cells, a self-discharge is expected to occur at a rate of “up to 3.0 percent” of full charge per month at 77°F (25°C). Therefore, if cells remain, for whatever reason, on open circuit (with no charge supplied) for prolonged periods of time, the affected cells may become sulfated and require corrective action in the form of a freshening charge, see Sections 5.2, 7.1 & 7.2.

10.6 Parallel Battery Strings

When strings of batteries of equal voltage are connected in parallel, the overall capacity is equal to the sum of the capacities of the individual strings. When paralleling valve-regulated batteries is necessary, the external circuit resistance should be matched for each battery. A wide variation in battery circuit resistance can result in unbalanced discharge (i.e., excessive discharge currents in some batteries and less discharge in others). As a consequence, cell failures in one battery string and the subsequent loss of performance capacities of that string will result in higher loads in the lower resistance interconnections of some parallel strings that may exceed the ratings of the battery interconnections and/or cables. C&D recommends paralleling strings to obtain higher capacity, to increase system reliability and with properly installed disconnects, perform maintenance on one string at a time.

10.7 High Temperature Operation

Operating a battery at temperatures exceeding 77°F (25°C) will reduce the battery life. Elevated temperatures accelerate the electrochemical reaction within the lead acid battery. For additional information, refer back to Section 8.4.

Appendix

Appendix A – Installation of Modules

The Liberty 2V battery systems can be shipped with the cells installed into the modules or separately. Modules with cells installed are stacked vertically and bolted to pallets for ease of transportation (See Figure A1 & A2). When cells are packed separately they are packaged in foam for safe transport and installed into modules on site (See Figure A3). It is essential and the responsibility of the customer/installer to be properly trained and have suitable equipment to handle these heavy products. It is the responsibility of the customer/installer to provide a room properly designed for a battery system, including appropriate ventilation, aisle space, egress, floor load capabilities and a level mounting surface.

Unpacking and Handling

Do not remove shipping materials if a storage period is expected. The battery modules are shipped in varying groups depending on cell size. Lag bolts are used to attach the modules to the pallet along with a protective honeycomb hood, cardboard packaging and shrink wrap (See Figure A1).

Carefully remove all shipping materials and dispose of properly. Once all shipping materials are removed unbolt the system from the shipping pallet. Each system will be provided with one base assembly (See Figure A2) for floor anchoring and should be removed first followed by any other bolted connection leaving only the module rivets (See Figure A4, A5). The design of the module allows for handling by a fork lift, portable crane or by a battery lift table. When handling modules it is very important to use a piece of insulating material such as shipping cardboard, plywood or rubber insulating mat between handling equipment & battery terminals. Always verify the lifting capacity of the equipment being used and never lift more than one module at a time. Always use both lifting straps in an “X” pattern as shown throughout this manual. The module assembly can be lifted by either the front flanges or by a combination of holes on both flanges (See Figure A4, A5 & A9). CAUTION: Cells are tightly fit however not completely restrained until system is completely assembled therefore never tilt module forward.

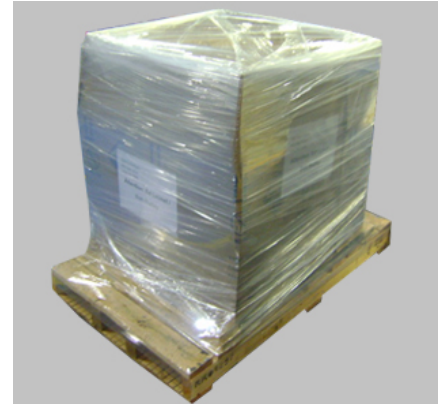

Figure A1

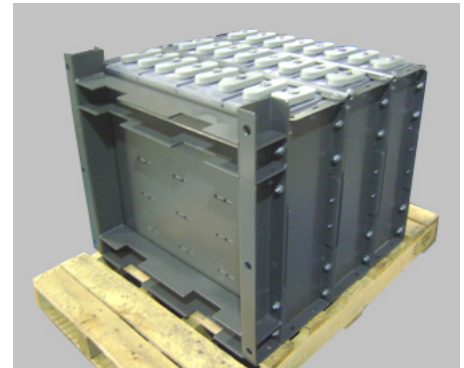

Figure A2

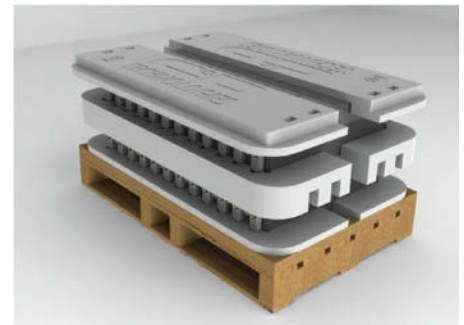

Figure A3



Figure A4



Figure A5

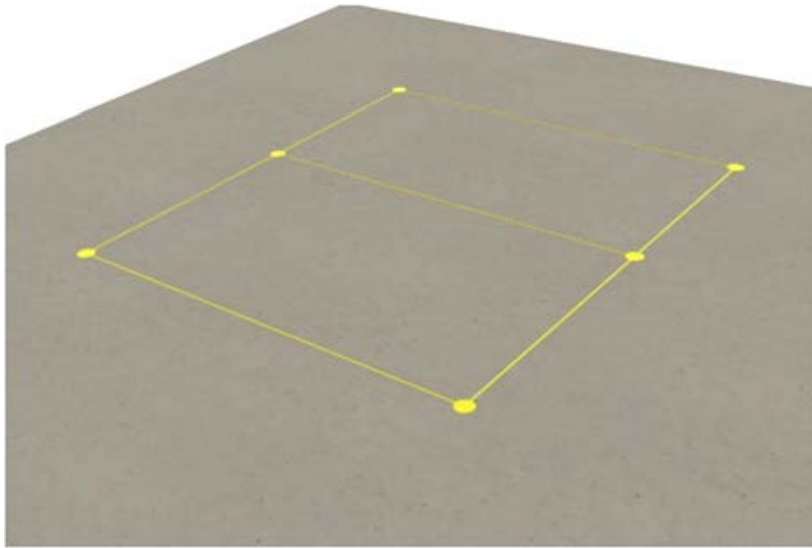

Figure A6



Figure A7



Figure A8

Floor Anchoring

Floor loading and anchoring requirements are the responsibility of the user/installer and all applicable building codes and regulations must be followed. C&D provides connection drawings, weights, dimensions, and floor loading information on our system drawings for reference which is supplied with every shipment. Anchor bolts are the responsibility of the user/installer and are not supplied with the order.

1. Where floor anchoring is required, place base assembly into position and mark the anchor locations using the base as a template (See Figure A6 & A7).
2. Six 13/16" [20.6mm] holes are provided in the system base for floor anchoring.
3. Install floor anchors and reposition base onto anchors (See Figure A8).
4. Install anchor hardware and verify top surface of base assembly is level in both axes, if necessary install shims to level base.
5. Once base assembly is level, torque anchors to proper rating based on manufactures specification. (See Figure A8).
6. A level base is particularly important for the stability and safety of high, narrow stacks.

If tool clearance is an issue rear anchors can be accessed using a standard 3/8" extension as shown.



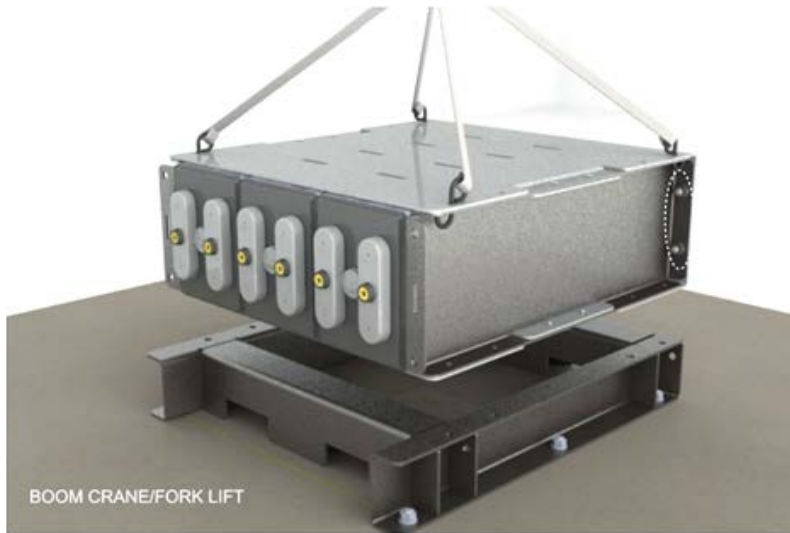

Figure A9



Figure A10



Figure A11

Module Stacking/System Assembly

With base properly installed, modules unpackaged and in the horizontal position, locate the C&D issued system diagram to verify proper cell orientation when stacking modules.

C&D recommends the following two methods for handling Liberty 2V modules.

1. Portable Crane/Fork lift:

In the case of limited access in the rear of the module install only the (4) 10mm bolts in the rear flanges prior to hoisting. Connect optional lifting straps in a "X" pattern as shown and hoist carefully.

Note: Depending on the battery type some sagging may occur while lifting however once released and in position will return to square (See Figure A9).

2. Battery Lift Table:

Again prior to hoisting, install only the (4) 10mm bolts in the rear flanges. Verify module orientation then position module on lift table keeping metal surfaces isolated from battery terminals. The modules flat top and bottom surfaces allow it to easily slide from the lift platform to the base with little effort (See Figure A10).

Note: When lifting battery modules always verify the lifting capacity of the equipment being used and never lift more than one module at a time.

3. Next, make only the lower tier module to base connections using (8) 10mm bolts (4/side). Torque to 40 ft-lb [55N*m].

Note: Only the Module – to – Base connection requires the use of all (8) bolt connections (See Figure A11).

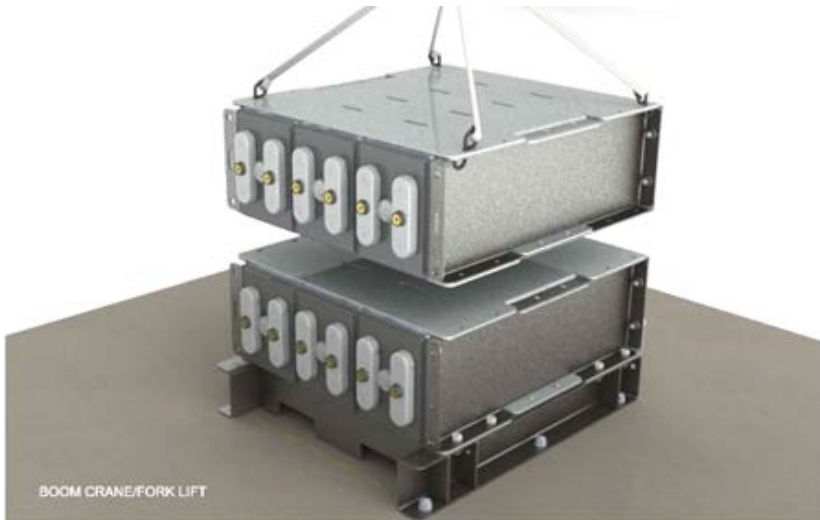

Figure A12



Figure A13



Figure A14

Module Stacking/System Assembly (Tiers 2 and higher)

1. Using either of the two lifting methods described on the previous sheet continue with stacking modules for tiers (2) on up. As mentioned before it is always a good practice to reference C&D connection diagram while stacking modules to assure proper cell orientation. Doing so can save time and effort in the future if a module is installed in the incorrect orientation.
2. Once the module is in position and bolt holes are in alignment make the Module – to – Module connection using (4) 10mm bolts (2/side) in the horizontal plane. Torque to 40 ft-lb [55 N*m]. (See Figure A14).
3. Follow these steps for any additional modules for tiers 2 on up.

Note: Module – to – Module connection only requires the use of (4) bolt connections per tier in the horizontal plane (See Figure A14).

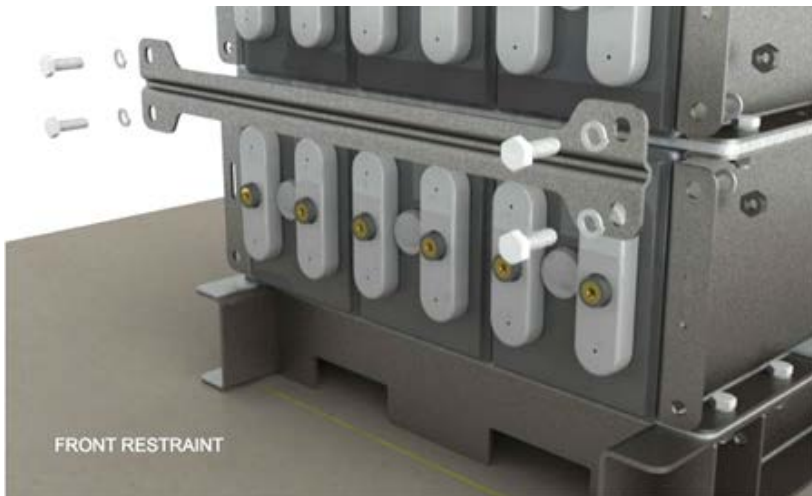

Figure A15



Figure A16



Figure A17

System Restraints

All systems are supplied from the factory with two types of restraints. These restraints are critical in maintaining the seismic rating of the system and must be installed properly.

Front Restraint

Front restraints are installed between each tier of the system to prevent cells from shifting in the event of an earthquake. With all of the modules properly stacked and in agreement with the C&D layout drawing attach the restraint bar using (4) 10mm bolt assemblies (See Figure A15).

Top Restraint

Each system/stack will be supplied with one top restraint. The top restraint will be installed on the upper most module to complete the assembly. The restraint will be installed using (6) 10mm bolt assemblies (See Figure A16).

Final Check

Once the top restraint is attached the system assembly is complete. Before attaching terminal plates and making series connections verify one last time the cell orientation matches the supplied C&D connection diagram.

Refer to Section 6 for mounting Terminal Plates & inter-cell connectors.

Stack Module Disassembly and Re-assembly Procedure

If a requirement to disassemble and re-assemble a module stack arises, follow the following procedure.

1. Starting with the uppermost module in the stack, remove the individual cells following the instructions shown in Appendix D.
2. Repeat until all the cells have been removed.
3. Disassemble the stack modules. Transport the bottom stack module to the desired installation location. Mark the location of the floor anchors and install, again matching the anchor holes in the floor-mounting base.
4. Be sure the floor mounting base or assembly is in position and level, and then torque the floor anchors. If the base is not level, use shims to level. A level base is particularly important for the stability and safety of these high, narrow stacks (See Figure A8).
5. If the assembly requires additional modules, use the lifting slings. Place additional modules, one at a time, on top of modules already in place. Properly align modules and mounting holes, and insert the M10 bolts, washers and nuts as shown in Figures A7 and A8. When all bolts are in place, check that assembly is plumb and level, then tighten the bolts to 40 ft-lb (55 N-m) using a torque wrench.
6. Reinstall the cells starting with the bottom module and working up. Perform the electrical connections last.

Appendix B - Terminal Connections

1. Remove any remaining factory-applied grease coating from the terminals with a dry cloth.
2. Lightly brush the terminal, cable lug, terminal plates and contact surfaces with a plastic brush or burlap.
3. Coat all electrical surfaces with NO-OX-ID grease. (Optional: Use heat gun or hot plate to melt and then apply the NO-OX-ID grease, no open flames).
4. (Optional) - Re-flow excess NO-OX-ID with heat gun and wipe excess.
5. Install hardware and torque to 110 in. lb. (12.4 N-m).
6. Wash hands after working with lead.

Reworking Terminal Connections: If a terminal connection needs to be reworked (for any reason) follow the below steps:

Once the battery string has been removed from service using properly insulated tools and all appropriate battery safety methods remove the suspect connection(s).

1. Remove any existing grease using a dry cloth.
2. With a neutralizing solution consisting of one-pound baking soda mixed with one gallon of water, wipe the cover and terminal seal area with a cloth moistened with the neutralizing solution. Do not allow the neutralizing solution to enter the cell. Rinse with clear water and dry thoroughly.
3. Lightly brush the terminal, cable lug or terminal plate contact surfaces with a plastic brush or burlap, removing any oxidized or corroded areas.

Note: Liberty 2V batteries terminals, buss bars, cable lugs and terminal plates are made of copper and have a thin layer of tin. Once the terminal connection is coated with protective NO-OX-ID type grease, any “exposed”, or “un-tined” areas, no matter if from the factory or due to over brushing, will be protected from oxidation by the grease and not require reworking. Optional: preheat the NO-OX-ID type grease and apply warm. After working with any lead component, wash your hands.

4. Coat all electrical surfaces with NO-OX-ID grease. (Optional: Use heat gun or hot plate to melt and then apply the NO-OX-ID grease, no open flames).
5. (Optional) - Re-flow excess NO-OX-ID grease with heat gun and wipe excess.
Re-Install hardware and torque to 110 in. lb. (12.4 N-m) and measure connection resistance.
If still > $\pm 10\%$ consult C&D.

Appendix C – MSDS Documentation

For the most up to date MSDS information, please visit the C&D Technologies public website.

Public Website - www.cdtechno.com

MSDS Sheets - <http://cdtechno.com/resource/msds.html>

Appendix D – Handling and Replacement of Individual Cells



Figure D1



Figure D2



Figure D3

A key design feature of the Liberty 2V battery is the provision for servicing individual cells. With a minimum amount of handling and downtime, individual cells can be changed in the field. In addition, disassembly and re-assembly of the stack modules may accommodate installation of a new battery if necessitated by a hard-to-access location. Once the battery string has been removed from service, the technician must use properly insulated tools and adhere to all appropriate battery safety methods.

1. Remove the connector covers from the subject module.
2. Disconnect the system ground connection.
3. For each connector attached to the cell, loosen (but do not remove) the terminal bolts at either end.
4. While holding the connector in one hand, remove the terminal bolts completely. Remove the connector and set aside. Repeat for other connectors.
5. After performing the electrical preparation described above, the steps to physically remove the cell or cells can be performed as follows.
6. Remove cell retaining bar, shown in Figure D1.
7. Attach the “cell puller tool”, part number RE05259. This tool, shown in Figure D2, is available from your local C&D Technologies Representative or directly through C&D Customer Service. (customersvc@cdtechno.com)
8. Prepare for cell removal by moving a platform lift or equivalent lifting apparatus in proximity to the bottom of the stack module from which the cell is to be removed. Make sure all exposed metal on the platform is insulated. Verify the capacity of the lifting apparatus is sufficient to safely lift the cell. **IMPORTANT:** Before removing the cell, note the orientation of the cell in the module, i.e., positive terminal up or down.
9. Pull the cell straight out onto the platform, shown in Figure D3.
10. Follow Steps 2, 3 and 4 in reverse order to physically install the replacement cell or reinstall a new disassembled battery. Do not perform the electrical connections at this time.
11. Note: There is also a connection drawing supplied with each battery that will aid in cell orientation and installation. When all cells for a given module have been installed, reinstall the cell-retaining bar.
12. Perform terminal and connector preparation.
13. Perform polarity check.
14. Reinstall connections.
15. Re-install connector covers.
16. Note: Liberty 2V cells should never be lifted by the terminals. Do not use the cell puller tool as a lifting device
17. Never remove more than one cell per tier at a time.

Appendix E – Battery Inspection Report



RS-1992

APPENDIX E BATTERY INSPECTION REPORT

TECHNICAL SERVICE DEPARTMENT
1400 UNION MEETING ROAD
BLUE BELL, PA 19422

Inspection by: _____

Date of Inspection: _____

C&D TECHNOLOGIES' 2-VOLT BATTERY AND CHARGER INSPECTION REPORT

User's Name: _____

Authorized Site Contact: _____

Installation Location: _____

Phone Number: _____

Other: _____

System OEM: _____

Installation by: _____

BATTERY & CHARGER SYSTEM INFORMATION

C&D Order # _____

Appearance of Following Battery Items

C&D Ship Date: _____

Positive Posts: _____

Date Installed: _____

Negative Posts: _____

Battery Model: _____

Cell Covers: _____

Cells X Strings: _____

Application: _____

Bus Voltage, Portable

Meter: _____

Bus Voltage, Equipment, Final: _____

Presence of Lubricant on cells? Yes No

Charger Size: _____

Charger Type: _____

Charger Serial #: _____

Charger Mfg: _____

Ambient Room

Temperature _____

Last Discharge: _____

Peak Load Current

Amp. Or KW _____

Typical Load

Current/KW _____

Cell Arrangement: _____

COMMENTS AND RECOMMENDATIONS:

Appendix F – Recycling

Lead-acid batteries are recyclable and C&D Technologies currently has a low cost, convenient, and environmentally safe collection and recycling program. Visit the C&D Web site at www.cdtechno.com for further information.



NOTES

NOTES
